

Cost-Effective Micro Spectrometer

ATP2000

Features

- Maximum spectral range: 190nm - 1100nm (up to 800nm wide)
- Signal acquisition frame rate: Up to 4Kfps
- Detector: Linear low-noise CMOS
- Detector pixels: 2048 or 4096 pixels
- Spectral resolution: 0.1 to 3.0 nm (depending on spectral range and slit width)
- Optical path structure: Cross C-T
- Integration time: 0.2ms to 65s
- Power supply: DC 5V \pm 5% or USB power
- ADC: 16bit, 15MSPS
- Fiber input interface: SMA905 or free-space input
- Data output interfaces: USB 2.0, UART, or Gigabit Ethernet
- 20-pin dual-row programmable expansion interface

Application

- Industrial Measurement Sensors
- LED Spectrophotometer
- Fluorescence Spectrophotometer
- Biochemical Analyzer
- Transmittance Detection
- Reflectance Detection
- Ultraviolet Gas Analyzer
- Multi-Parameter Water Quality Analyzer

Description

The ATP2000 series optical fiber spectrometer from Optosky is a cost-effective, high-performance solution, with over 30,000 units shipped and broad industry use. It features a UV-enhanced CMOS detector (2048 or 4096 pixels), covering 190-1100nm wavelengths, with exposure times as short as 0.2ms. Models include the ATP2000P (high SNR), ATP2000H (1kfps), ATP2000SH (4kfps), ATP2000-4 (4096 pixels), and ATP2000D (ultra-low noise).

Perfect for applications in environmental monitoring, industrial control, and research, the ATP2000 series meets growing demands for reliable and affordable optical analysis. It leads the Cost-effective Micro Spectrometer market in spectroscopy and chemical analysis.

Model	Description
ATP2000P	High signal-to-noise ratio, 300Hz frame rate.
ATP2000P-LVF	High signal-to-noise ratio, 300Hz, with LVF.
ATP2000H	High-speed spectrometer, 1Kfps.
ATP2000SH	Ultra-high-speed spectrometer, 4Kfps, Gigabit Ethernet.
ATP2000-4	4096 pixels, 25% higher resolution.
ATP2000D	Ultra-low noise, 7x less than ATP2000P.



Figure 1: Left: ATP2000 Cost-effective Micro Spectrometer, Right: ATP2000SH High-Speed Micro Spectrometer.

1. Selection Guide

Model	Description
ATP2000P	High signal-to-noise ratio, frame rate up to 300Hz.
ATP2000P-LVF	High signal-to-noise ratio, 300Hz frame rate, built-in LVF to eliminate second-order diffraction, ensuring a smooth spectrum.
ATP2000H	High-speed optical fiber spectrometer, frame rate up to 1Kfps.
ATP2000SH	Ultra-high-speed optical fiber spectrometer, frame rate up to 4Kfps (4KHz), Gigabit Ethernet output.
ATP2000-4	4096 pixels, 25% improved resolution.
ATP2000D	Ultra-low noise spectrometer, 7x lower noise than ATP2000P, with programmable pixel integration time for better SNR.

2. Performance

	Parameters	ATP2000D	ATP2000P	ATP2000H	ATP2000SH	ATP2000-4	
Detector	Type	UV-enhanced linear CMOS					
	Detection Spectrum Range	190-1100 nm					
	Effective Pixels	2048				4096	
	Pixel Size	14×200μm				7×200μm	
	Sensitivity	1300V/(lx·s)					
	Dark Noise	0.4V/RMS					
Optical Parameters	Wavelength Range	200-400nm, 200-850nm, 200-1000nm, etc. Customizable ranges (maximum 800nm)					
	Optical Resolution	0.1-3 nm (depends on slit and spectral range)					
	SNR	>450:1					
	Dynamic Range	> 3000: 1					
	Optical Design	F/4 cross-asymmetric C-T optical path					
	Incident Slit Width	5, 10, 25, 50, 100, 150, 200 μm (other sizes customizable)					
Incident Light Interface	SMA905 fiber interface, free space						
Electrical Parameters	Integration Time	1ms-65s		0.2ms-60s	1ms-65s		
	Frame Rate	300fps		1Kfps	4Kfps	100fps	
	Data Output Interface	USB 2.0 or UART			Gigabit Ethernet	same as ATP2000P	
	ADC Bit Depth	16bits					
	Power Supply	USB power supply, DC 5V±5%			DC5V±5%	same as ATP2000P	
	Operating Current	170mA			2A	170mA	
Physical Parameters	Operating Temperature	-10~40 °C					
	Operating Humidity	< 90% RH (non-condensing)					

	Dimensions (mm)	102×72×34	127×72×24.5	same as ATP2000P
	Weight (g)	230	270	230

3. Main Performance Test Reports

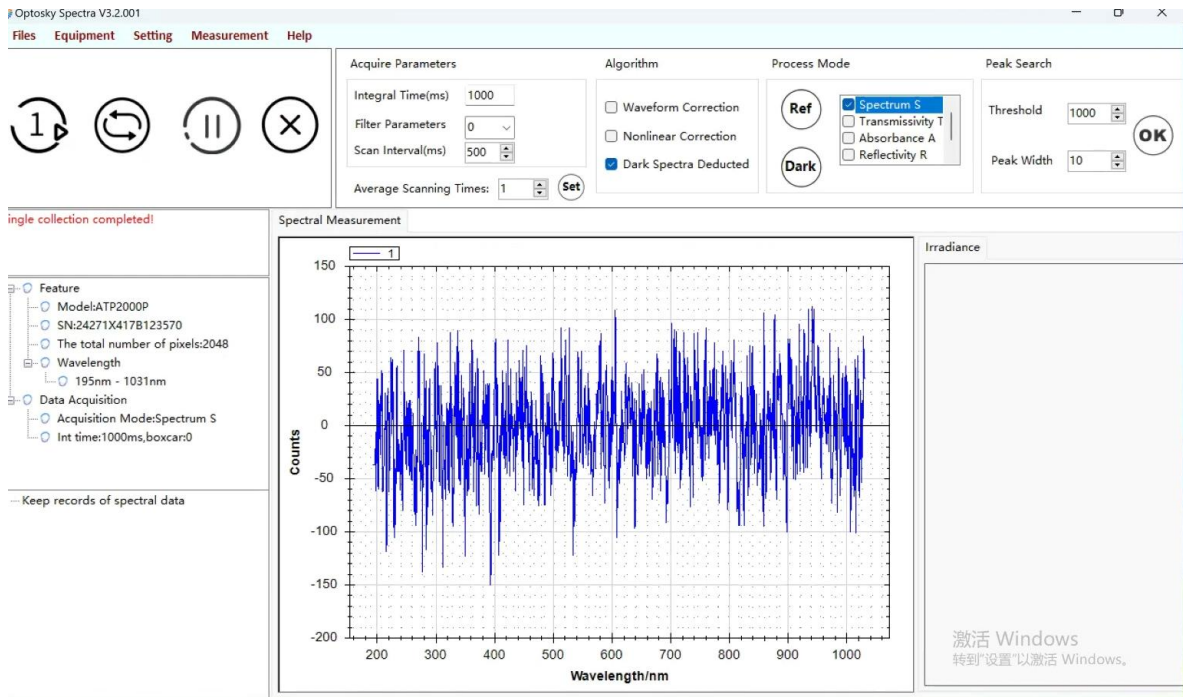

Figure 2: ATP2000P Dark Current Test (1000ms)

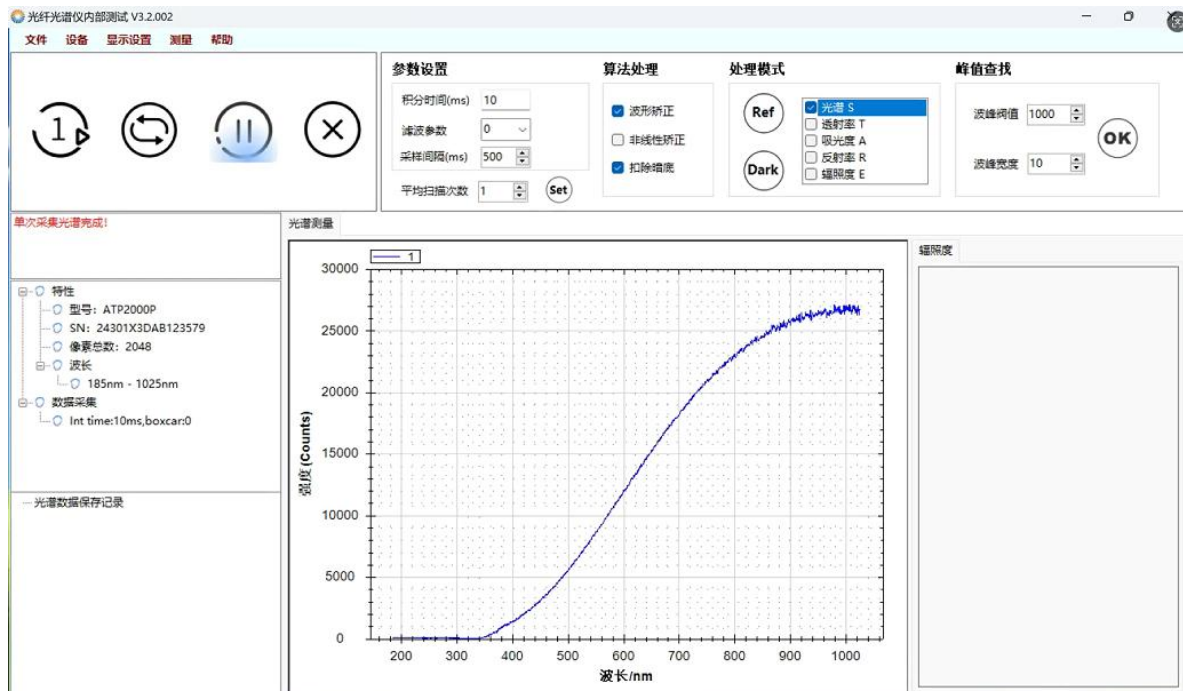

Figure 3: ATP2000P Waveform Calibration

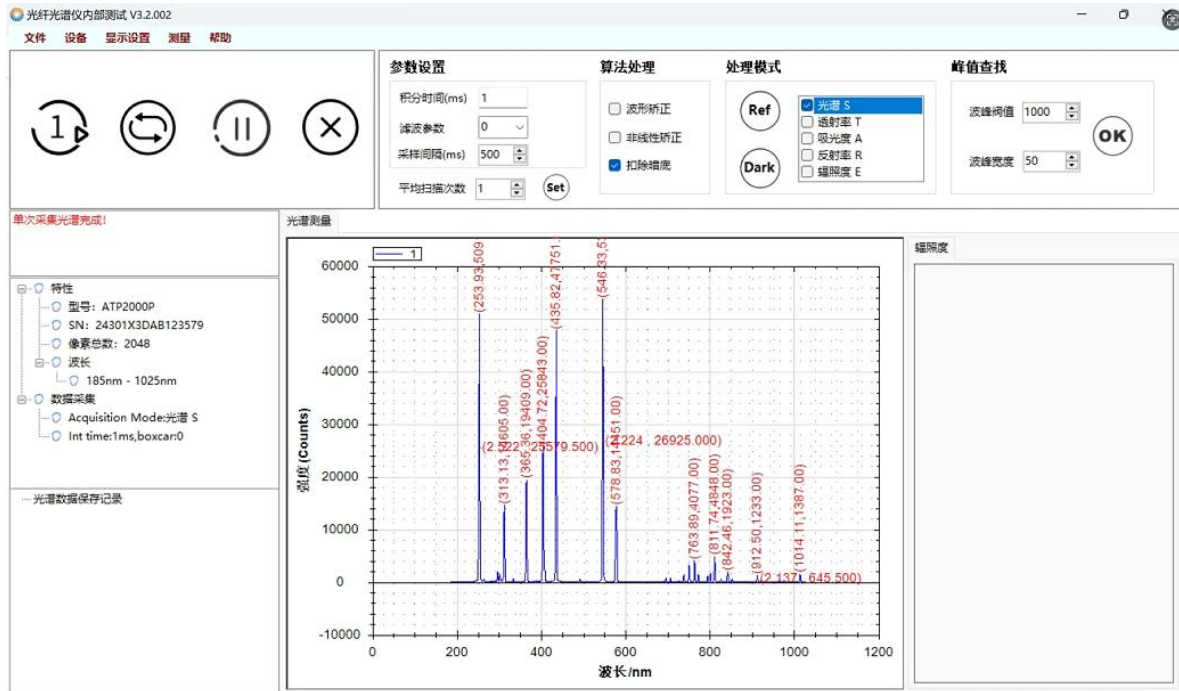

Figure 4: ATP2000P Resolution - 2.224nm @ 546.33nm

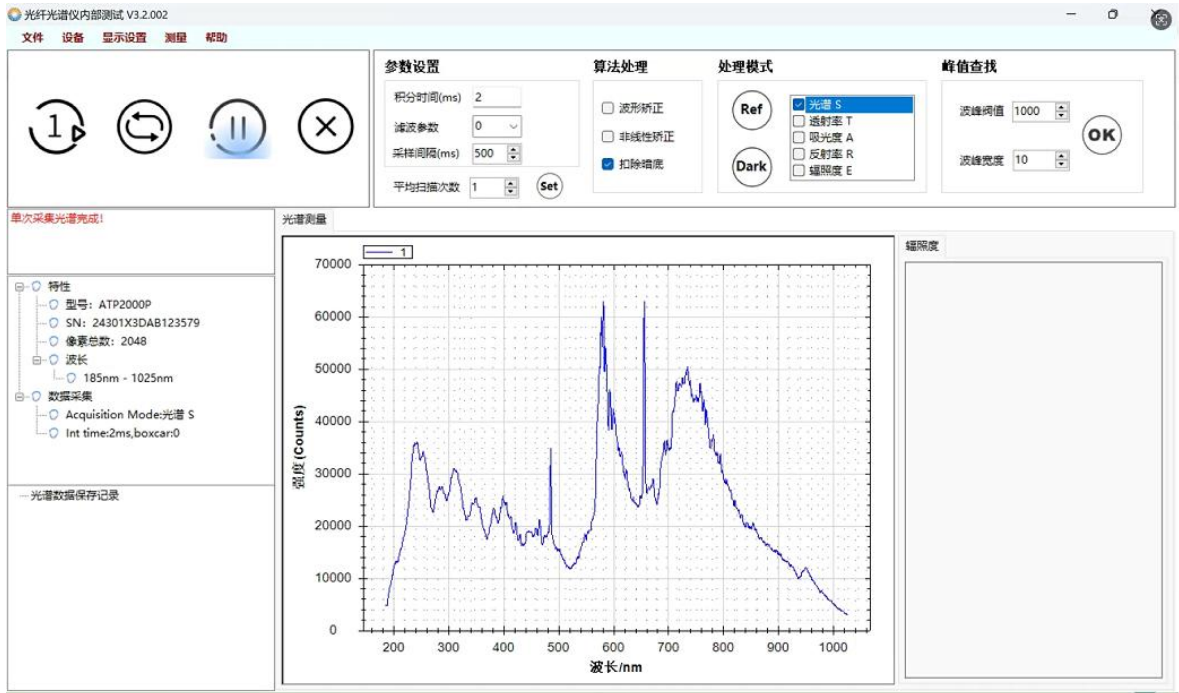

Figure 5: ATP2000P Deuterium-Halogen Lamp Test Spectrum

4. Physical Images



Figure 6: ATP2000 and ATP2000SH Physical Images

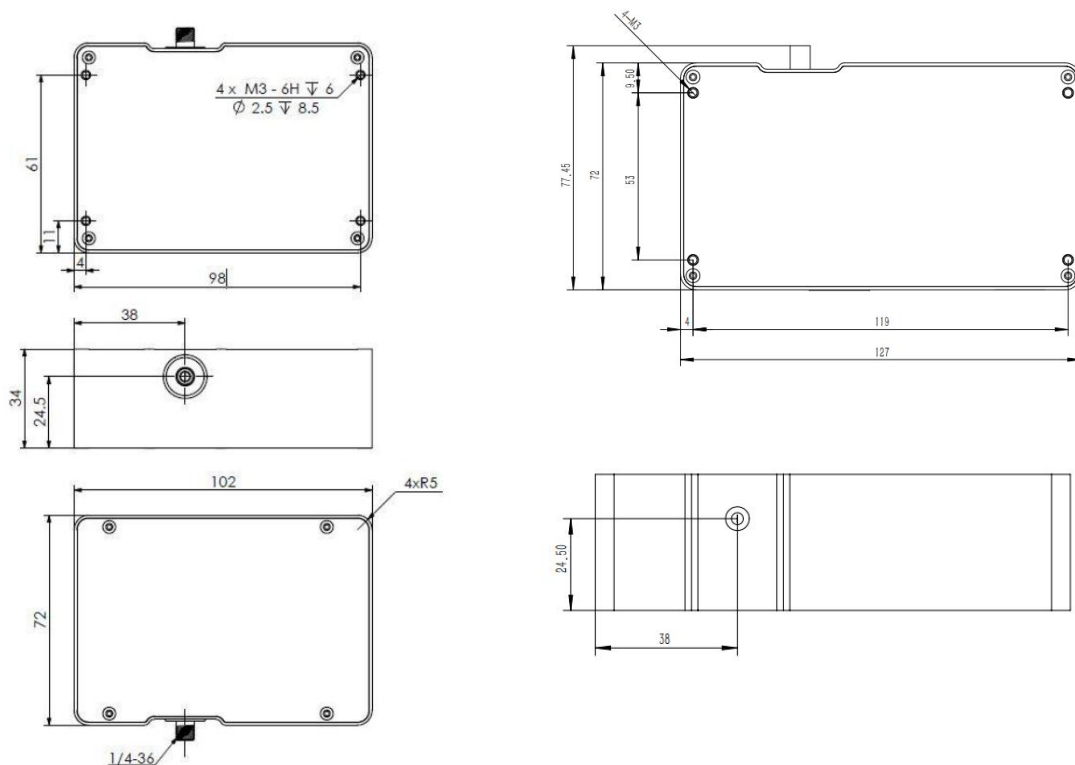

Figure 7: Left: ATP2000P Dimension Diagram; Right: ATP2000SH Dimension Diagram

Product data information is current as of publication data. Products conform to specifications per the terms of Optosky Standard warranty.

5. Accessories

Standard Accessories	
1	USB2.0-USB Data Cable
Optional Accessories	
1	UV-visible light-resistant optical fiber
2	Spectral analysis sample cell (disc-shaped)
3	Standard diffuse reflectance whiteboard
4	Transmission/Reflectance measurement integrating sphere bracket

6. Application Scenarios and Measured Data

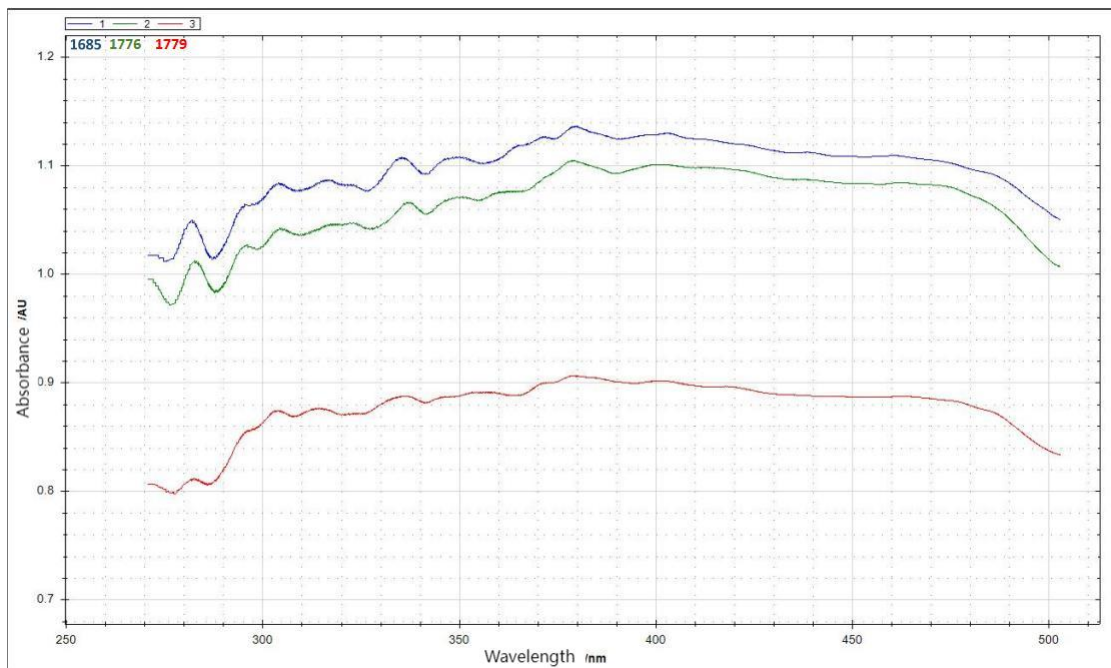

Figure 8: Absorbance spectra of sugar crystals at different thicknesses (1/3/5cm) measured with the ATP2000P

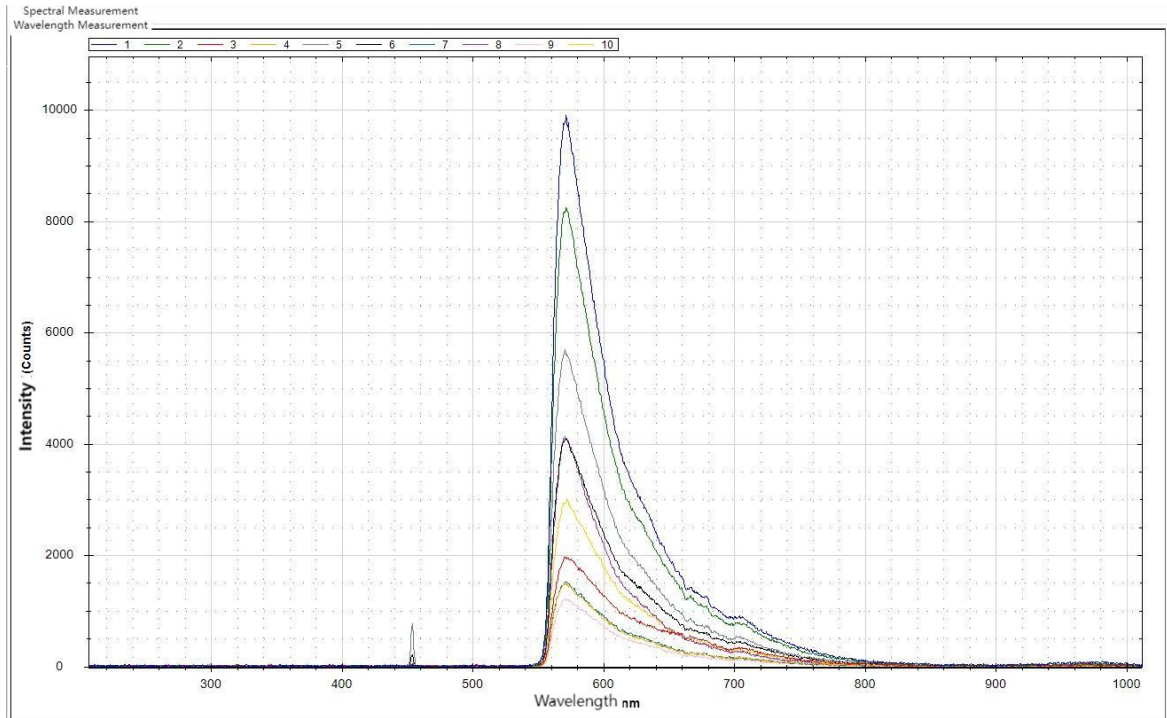

Figure 9: Fluorescence intensity spectra of cosmetics measured with the ATP2000P